

**LUMINISME**

Matériel	4
Le dispositif : la boîte	6
Les animations	12
Version finale	20

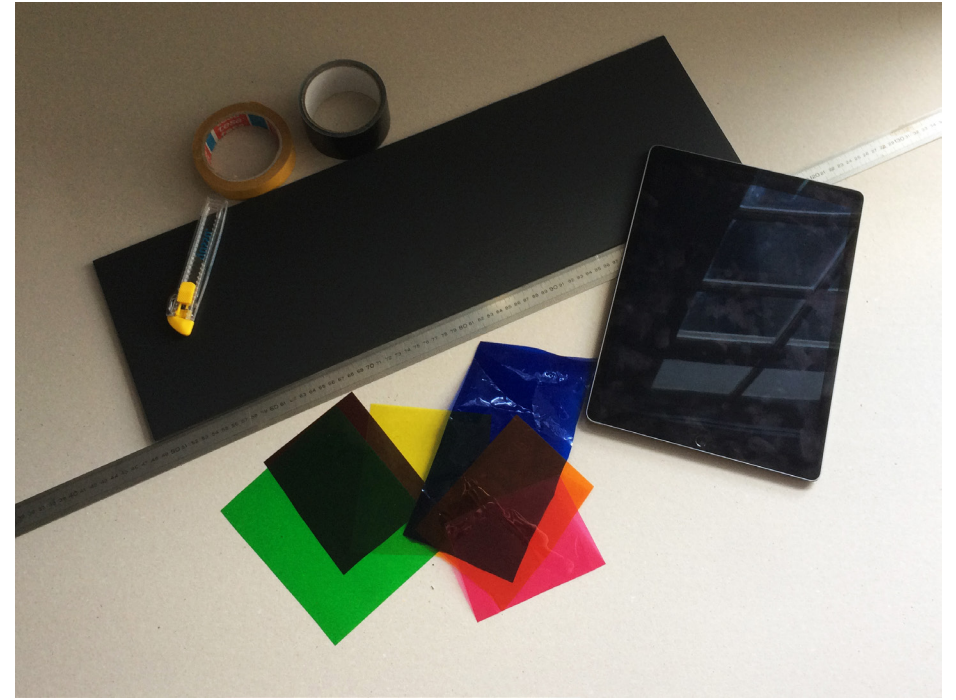

Pour réaliser l'expérience ... il vous faut :

- > Carton plume 5mm noir
- > Tablette
- > Animation à télécharger
- > Règle
- > Cutter
- > Double face
- > Gaffer
- > Gélamines de couleur (RVB principalement)

# LE MATÉRIEL

Fabriqué votre boîte à l'aide du carton plume aux dimensions de votre Ipad, ici nous avons utilisé un Ipad Pro 12". Pour notre expérience nous avons réalisé une boîte triangulaire afin que deux utilisateurs puissent essayer l'expérience en même temps. Suivez le patron suivant afin de réaliser votre boîte.

Dimensions (en cm)

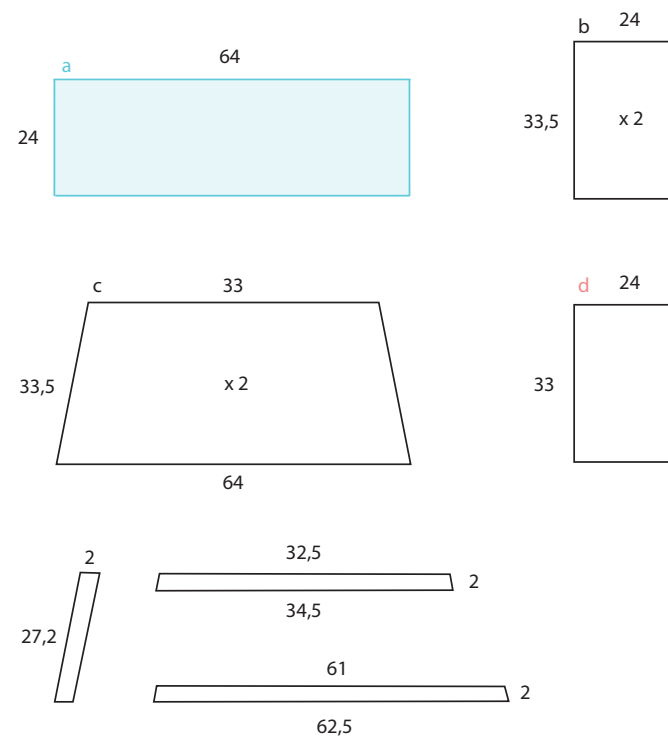
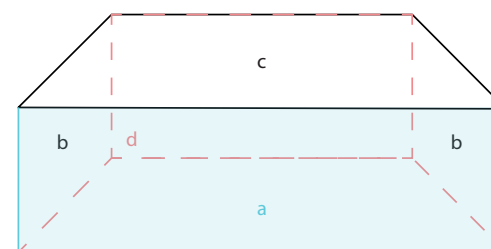

# LE DISPOSITIF : LA BOÎTE

# Dimensions (cm)

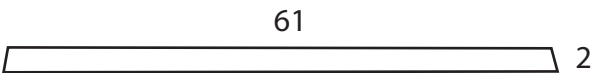
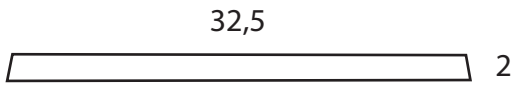
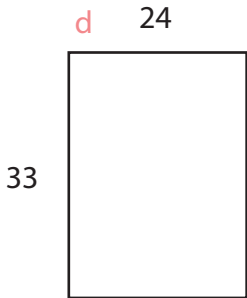
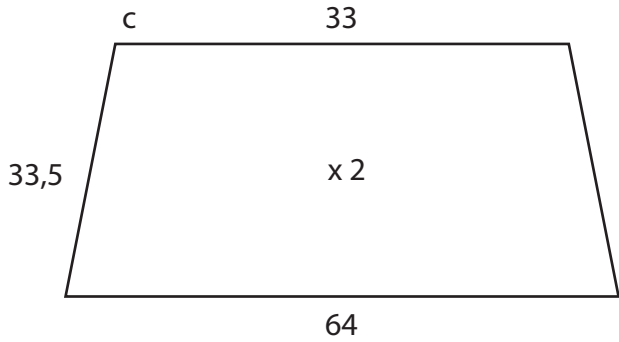
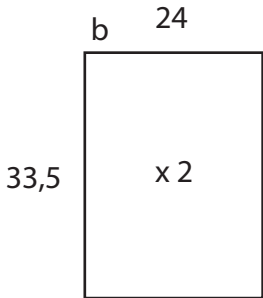
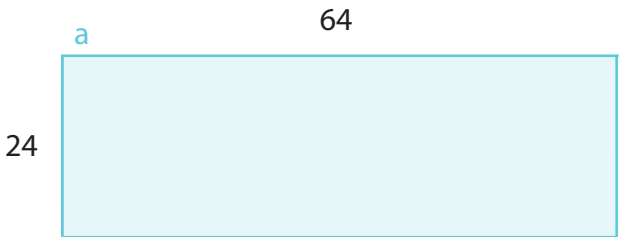
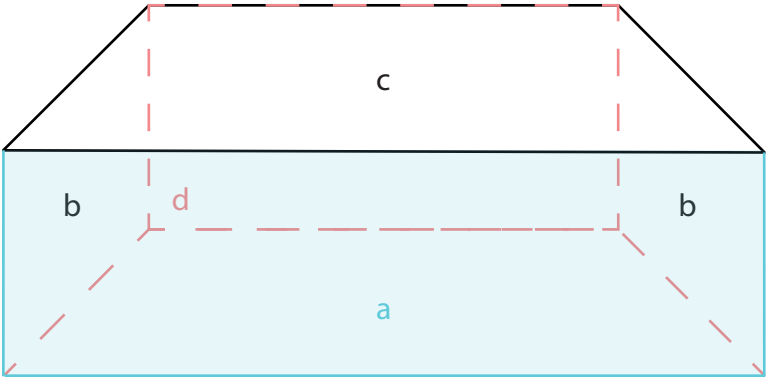

62,5

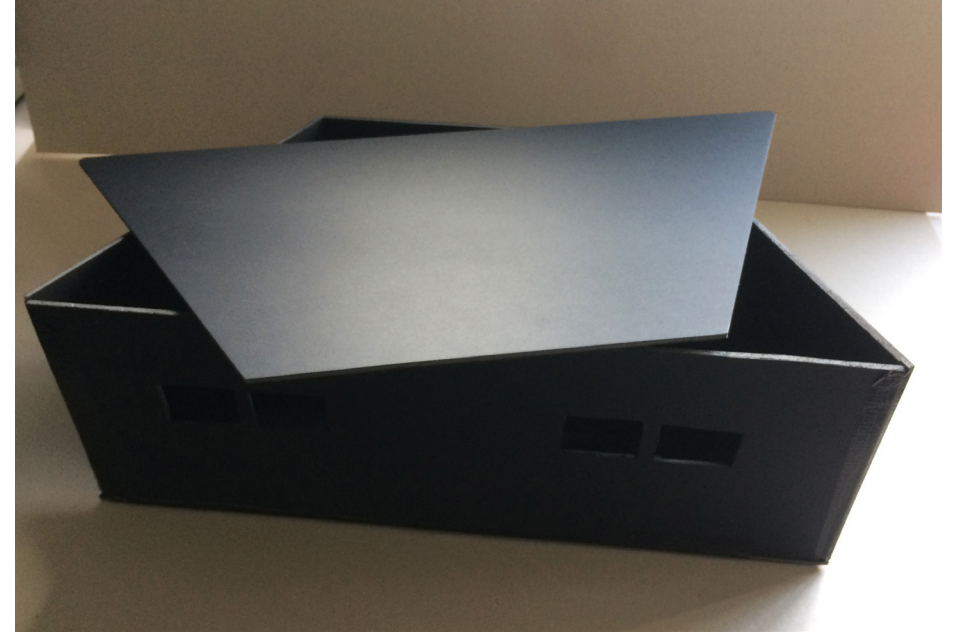

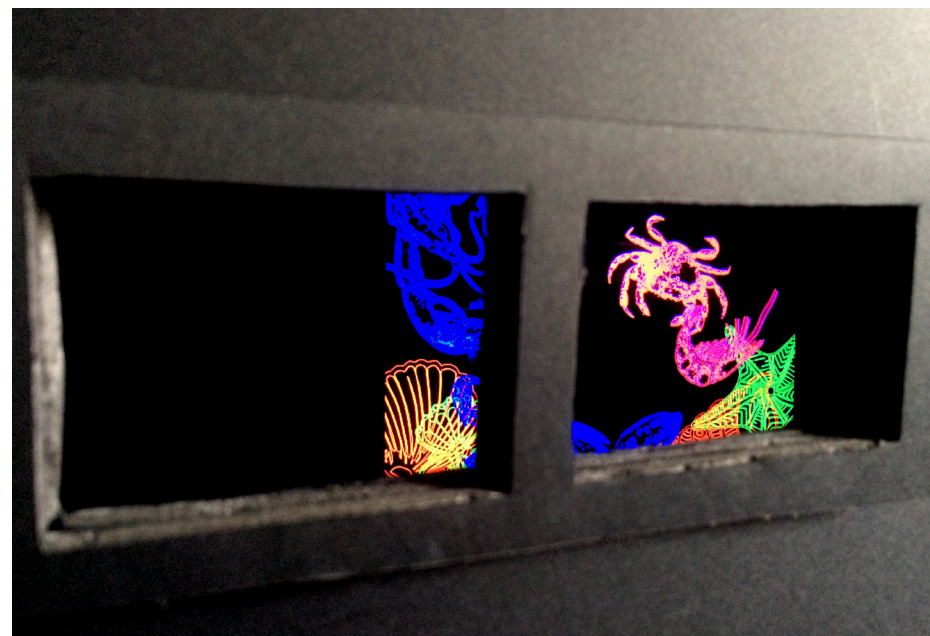

# LES ANIMATIONS

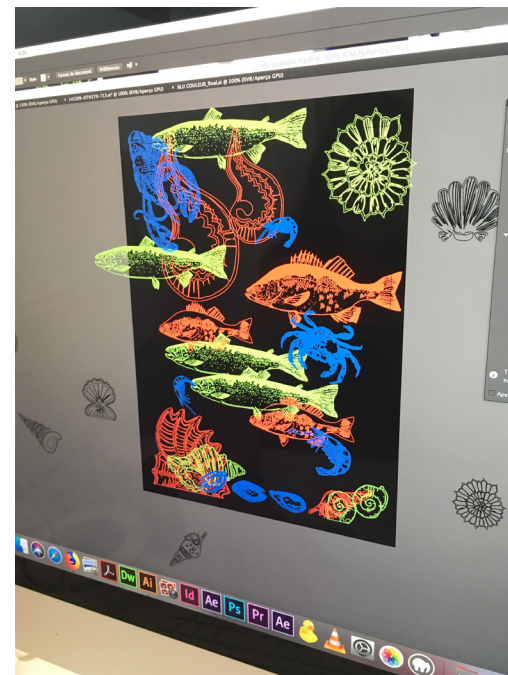



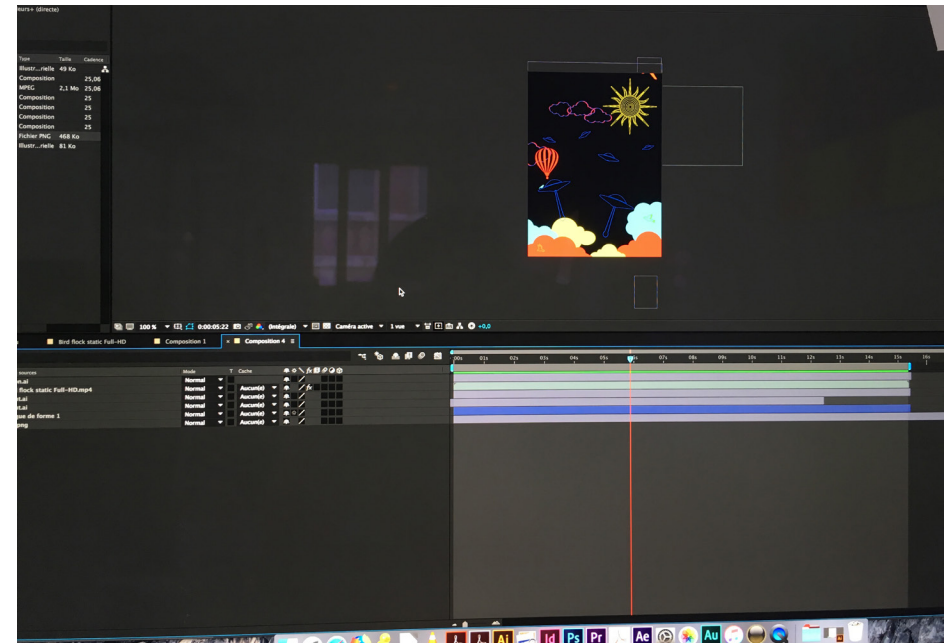
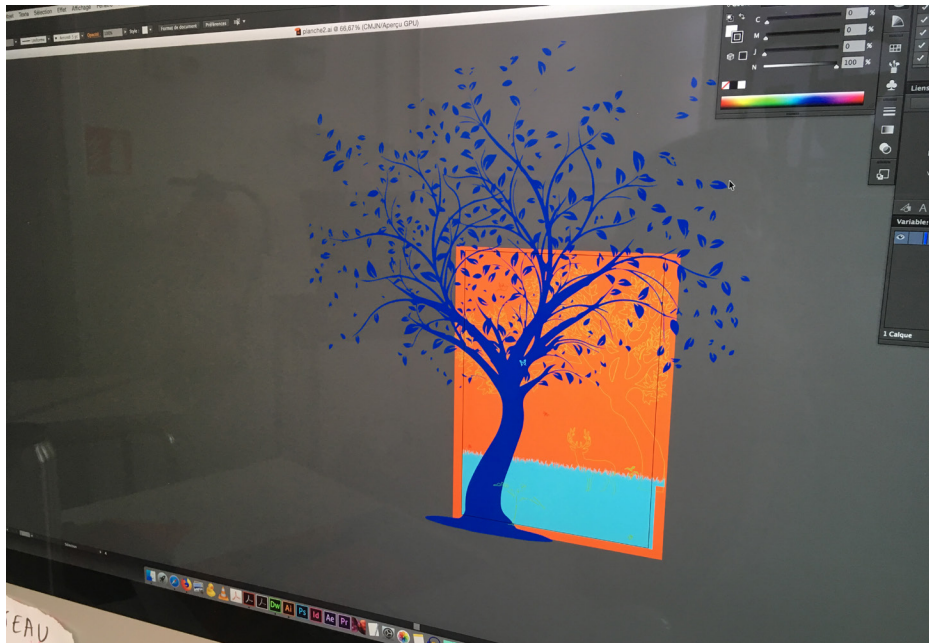
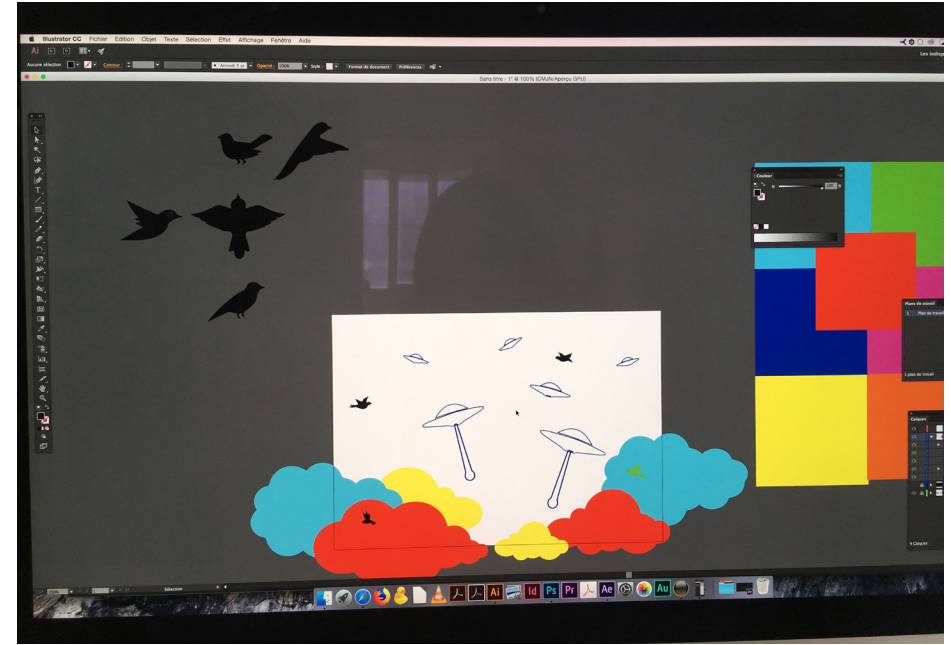
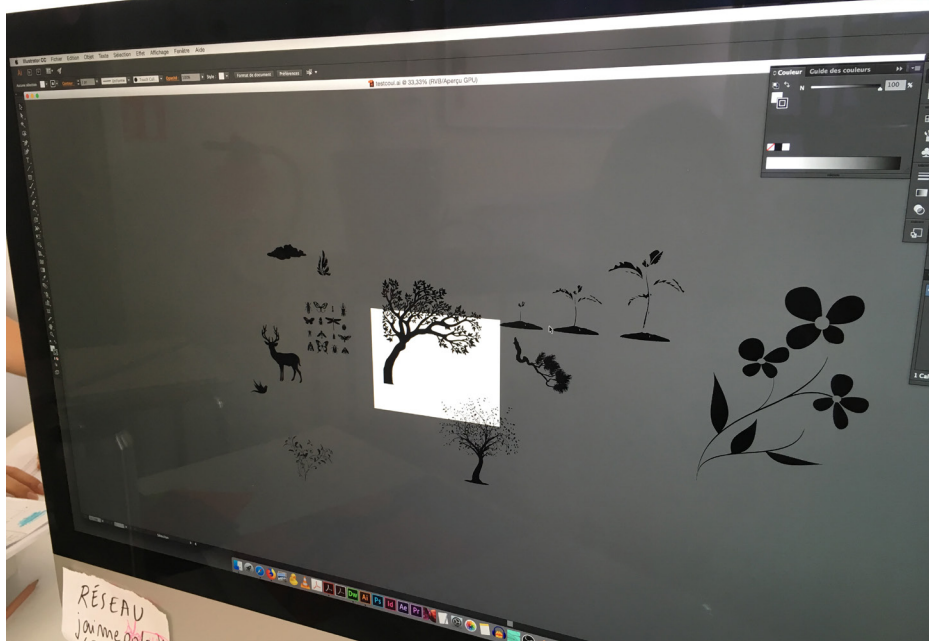

# LUMINISME

Combien y'a-t-il d'oiseaux ?

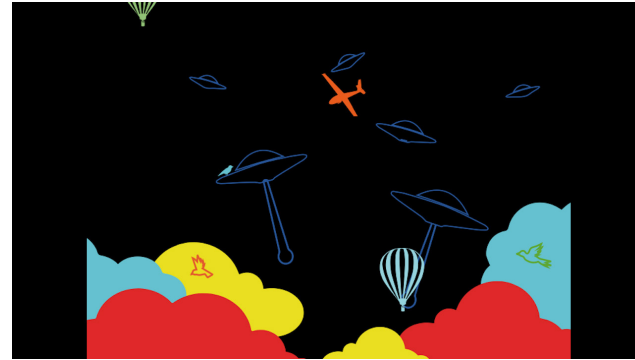

Combien y'a t-il de coquillages?

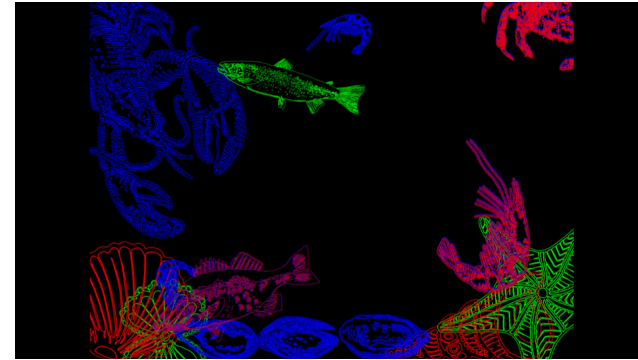
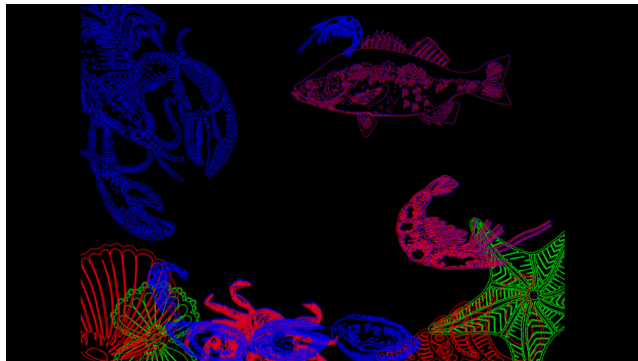
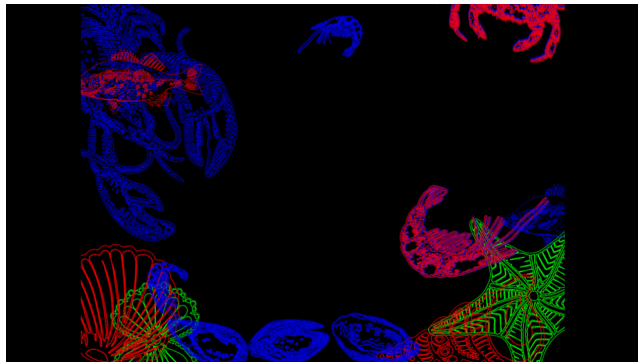

PHYSIQUE AUTREMENT

Réalisation

Schoenlaub Clara  
Kalaj Bernadette  
Nguyen Sylvie

# VERSION FINALE

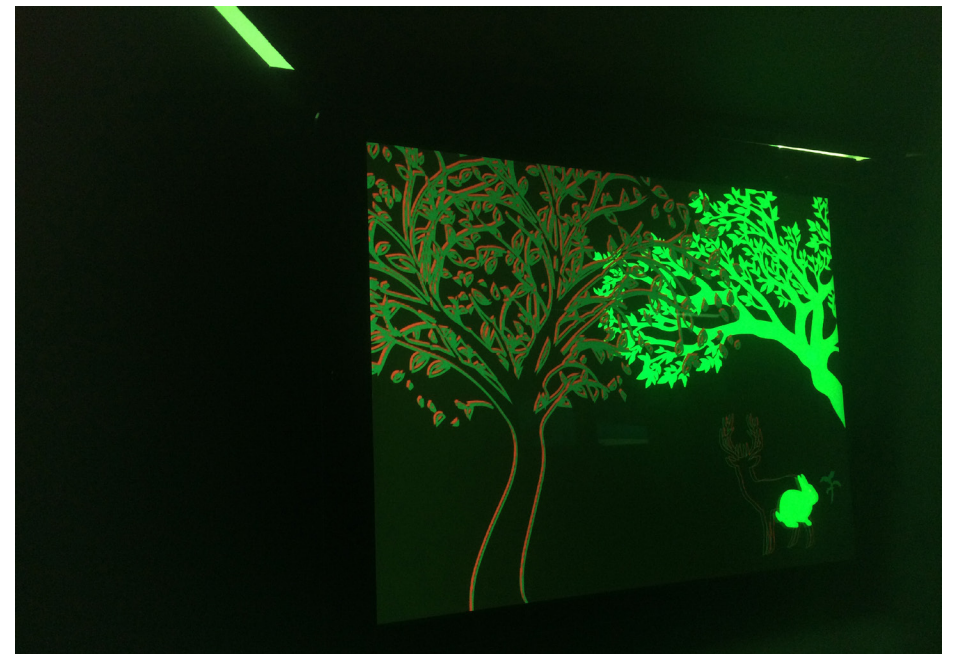

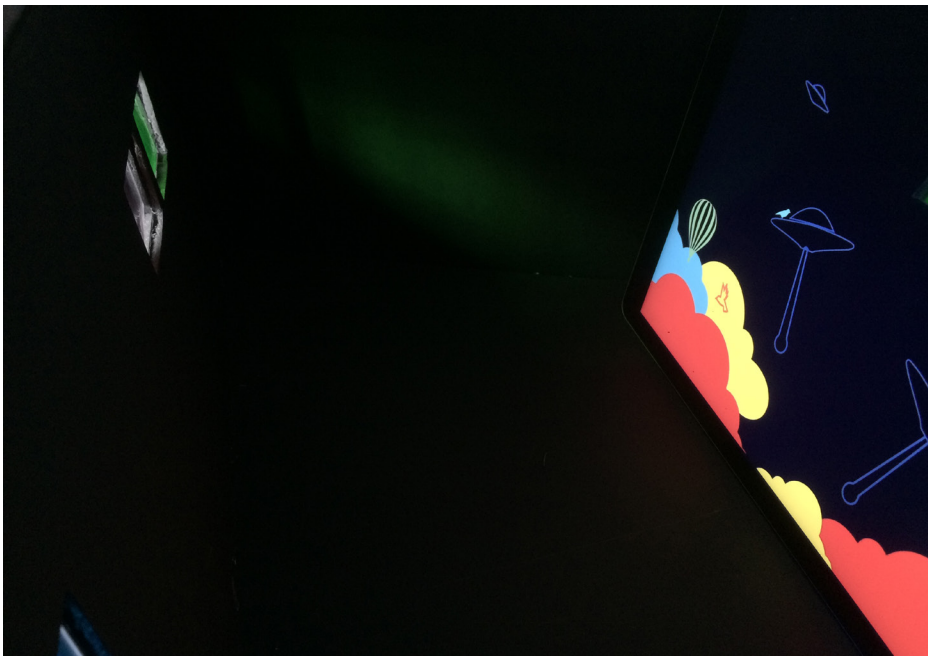
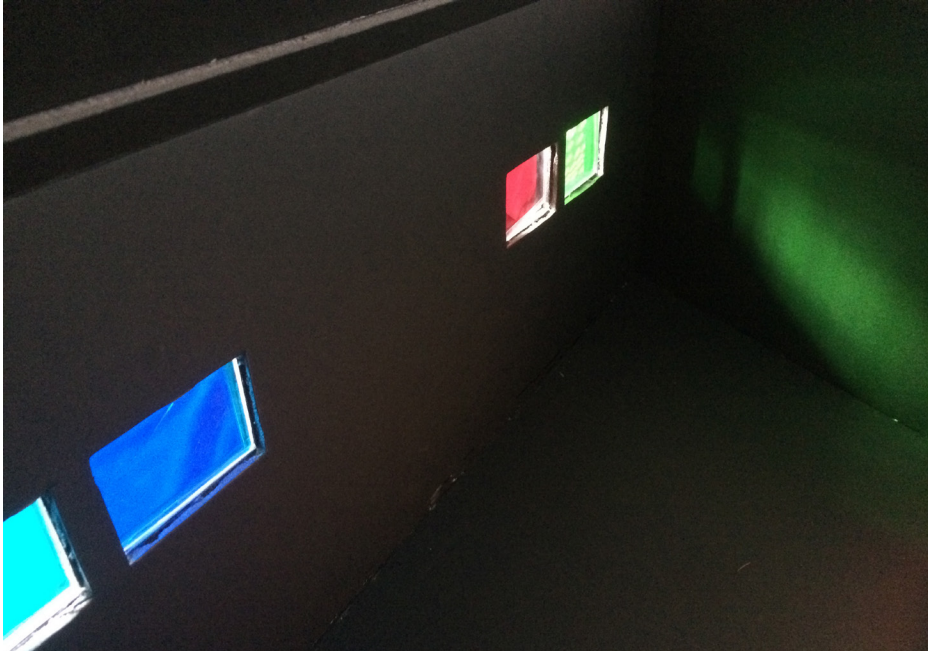

Sylvie Nguyen  
Bernadette Kalaj  
Clara Schoenlaub

Réalisation dans le cadre du workshop  
«Physique Autrement» autour de la lumière  
encadré par Florence Jamet-Pinkiewicz  
(Coordinatrice de la section DSAA DCN)  
et Julien Bobroff (physicien).

École Estienne, Paris, Mai 2018