

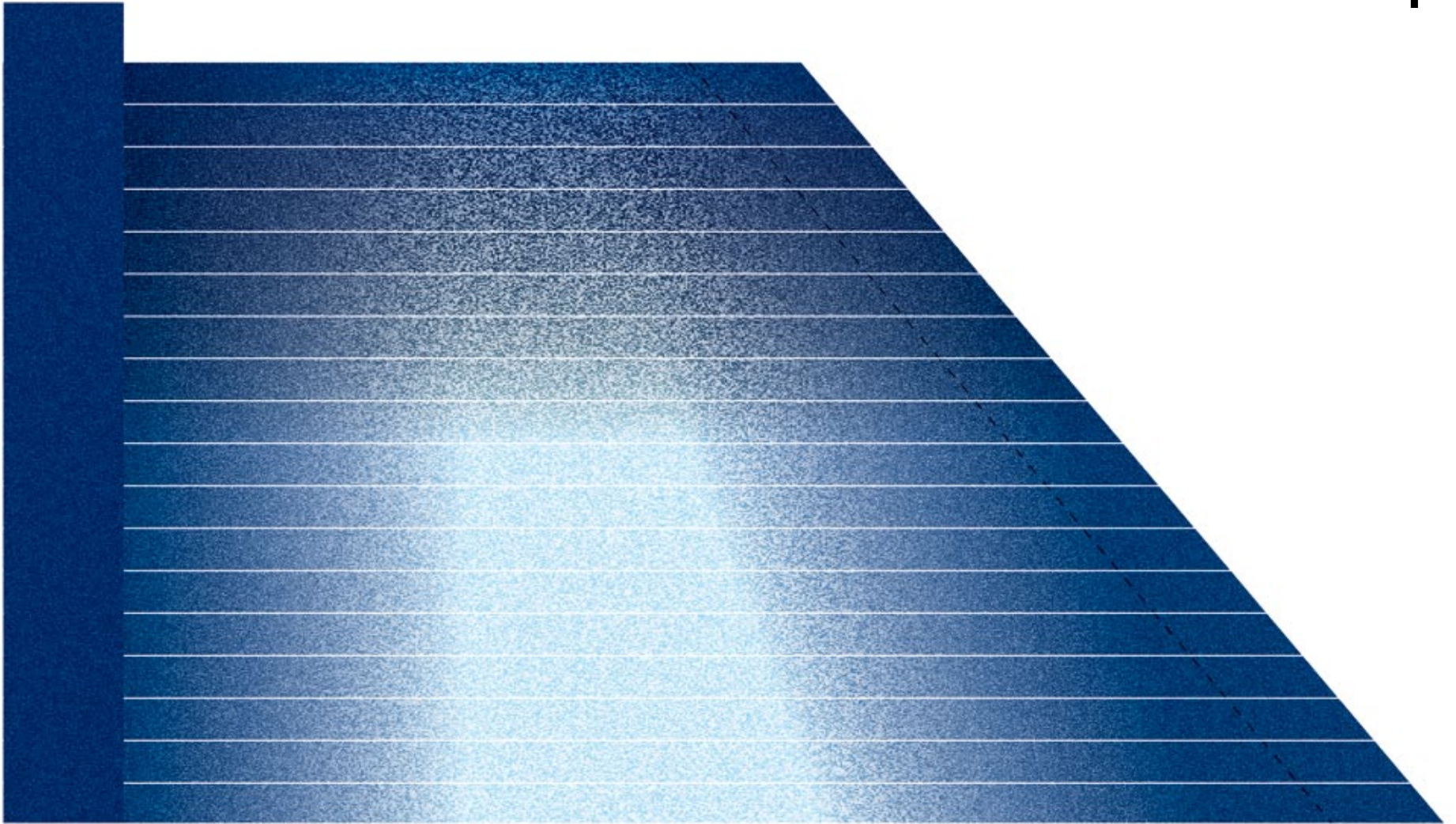



**mødel**  
**& instructions**

# électron s shape



# électron s shape

cut   
glue   
assemble 

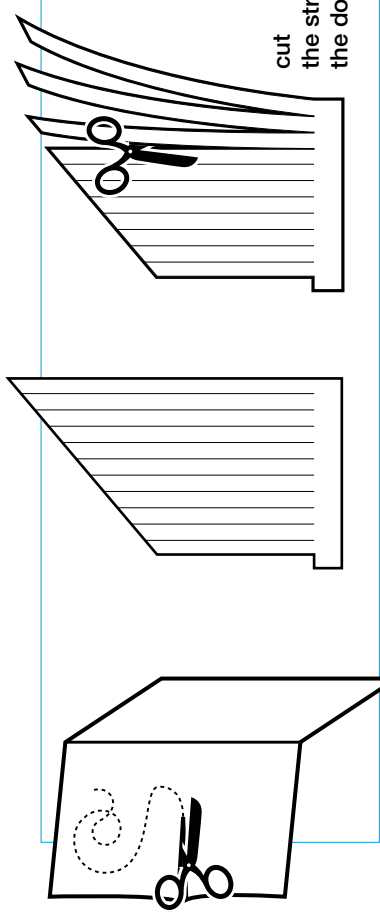

cut  
the stripes following  
the dotted lines

cut the blue pattern

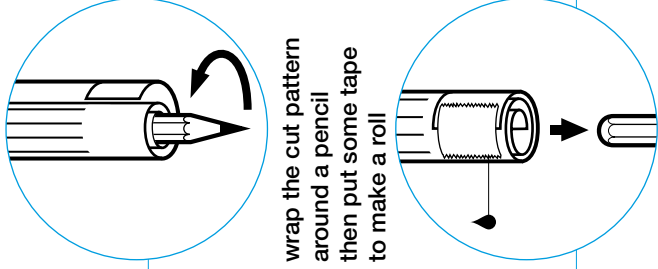
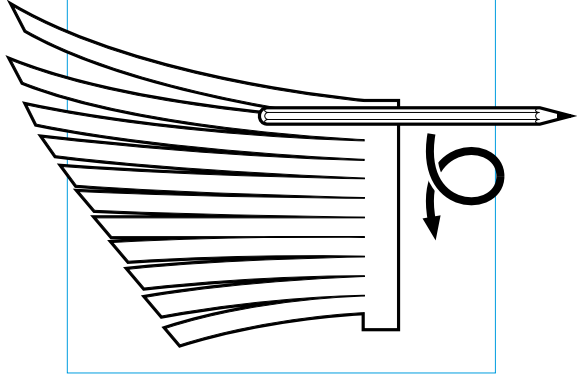

wrap the cut pattern  
around a pencil  
then put some tape  
to make a roll

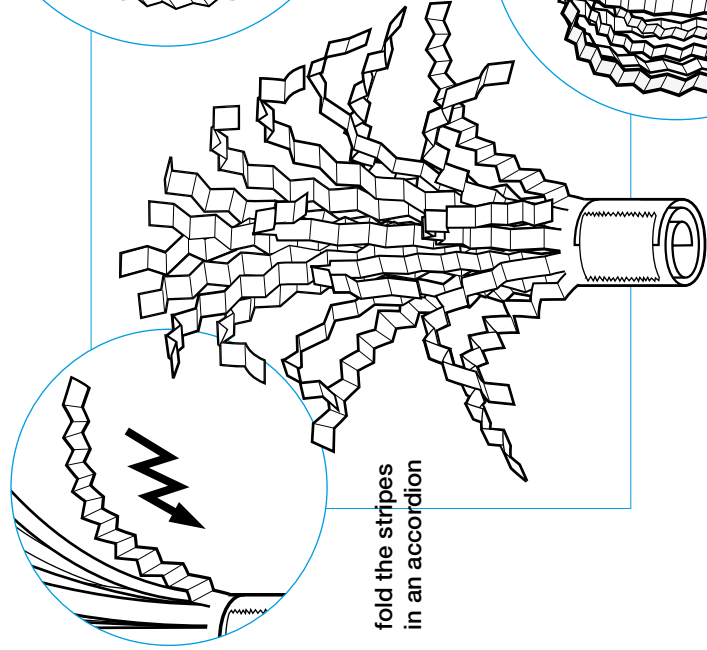
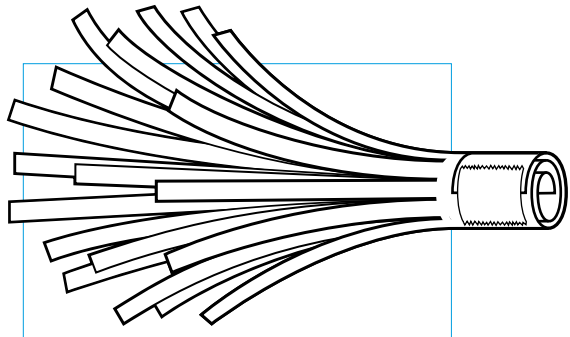

fold the stripes  
in an accordion

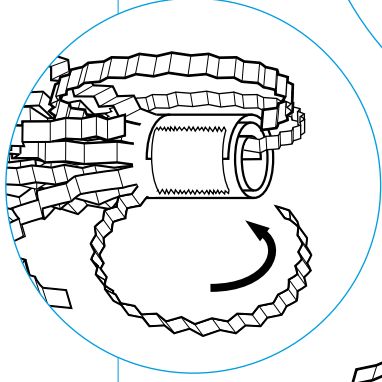

put and trap  
the stripes  
into the opposite  
side of the roll



pair of  $C(\infty)$ per

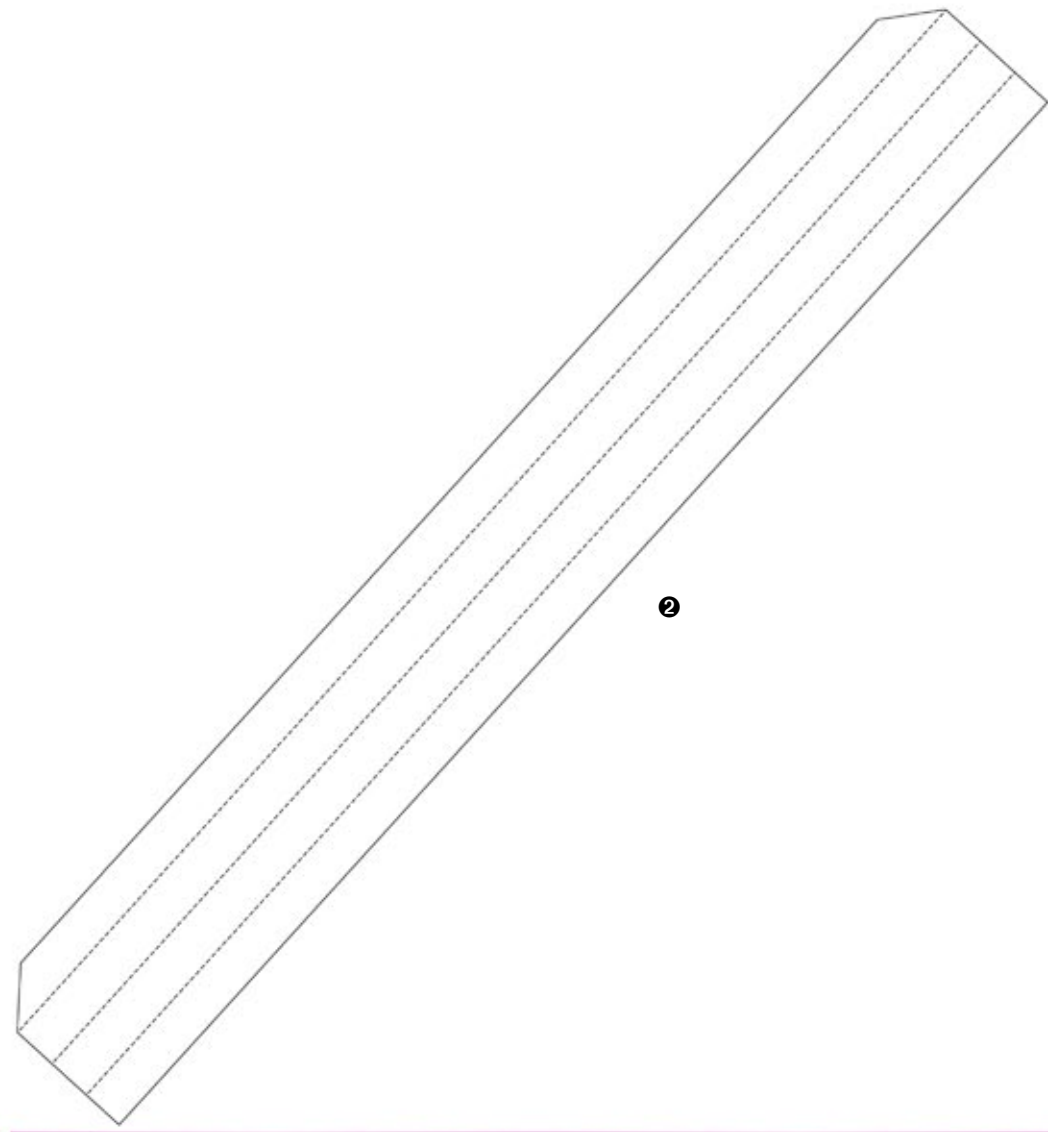

1

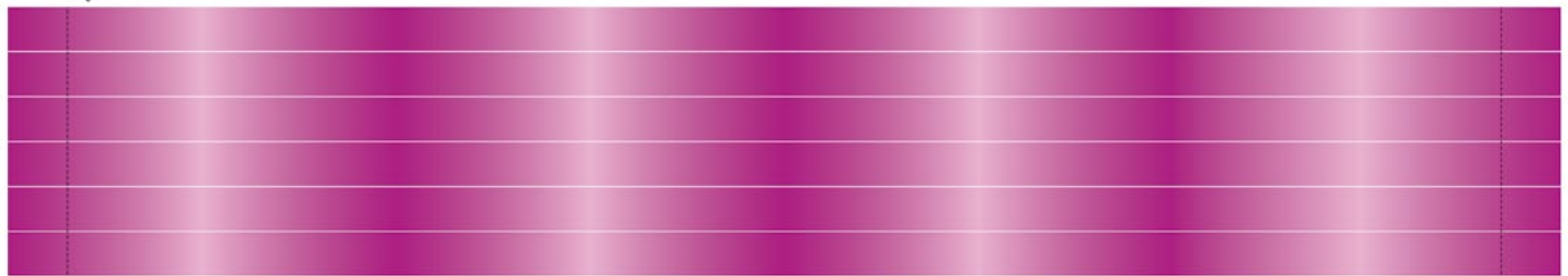

# pair of C(∞)per

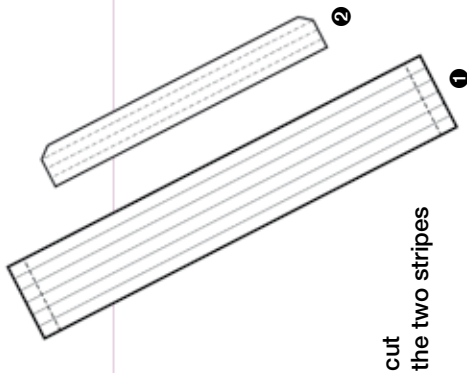

cut the two stripes

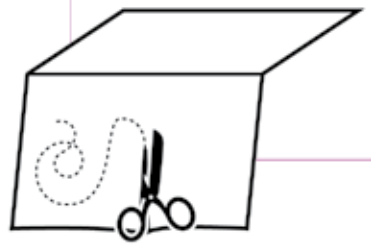

cut  
glue  
assemble

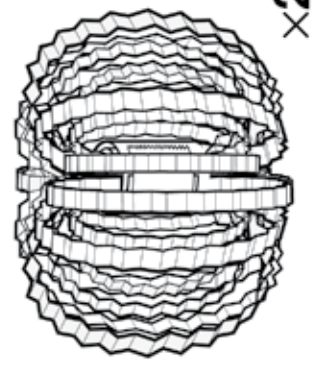

create a second electron following the instructions

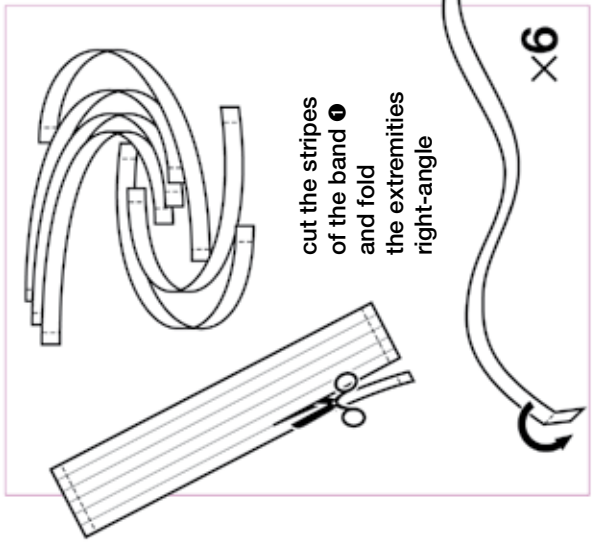

cut the stripes of the band 1 and fold the extremities right-angle

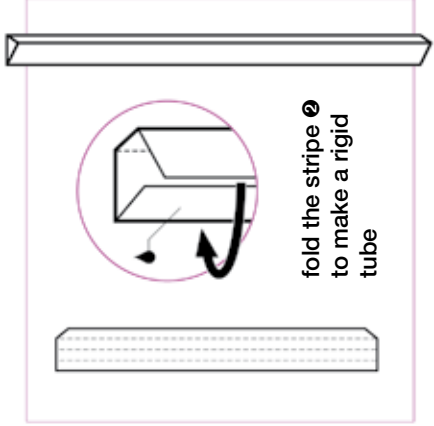

fold the stripe 2 to make a rigid tube

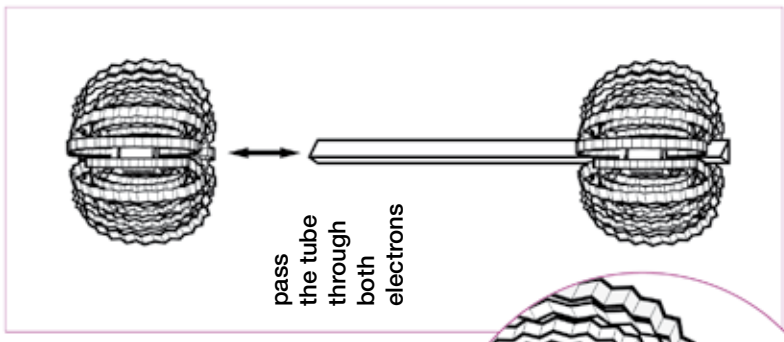

pass the tube through both electrons

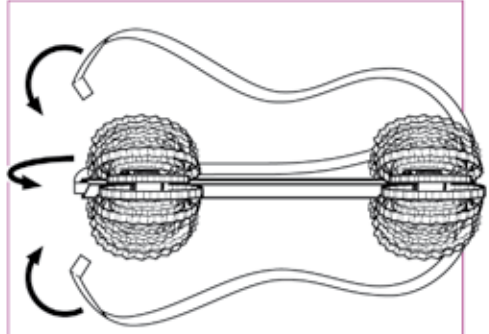

trap the extremities of each stripe between the tube and the electrons

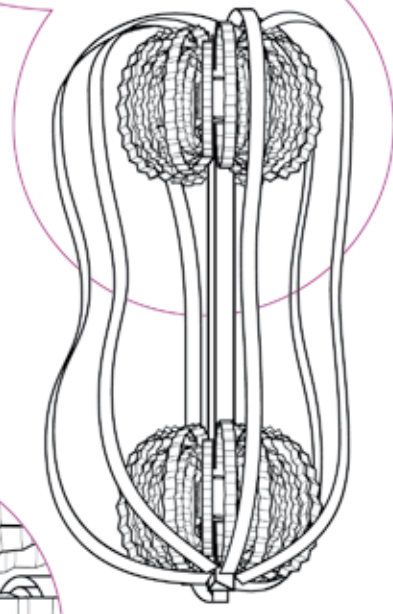
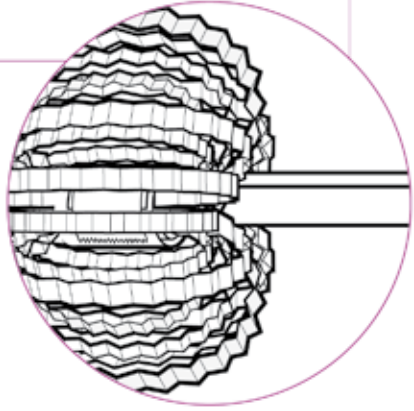
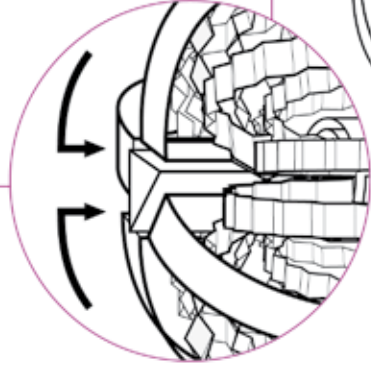

# lévitation of a magnet

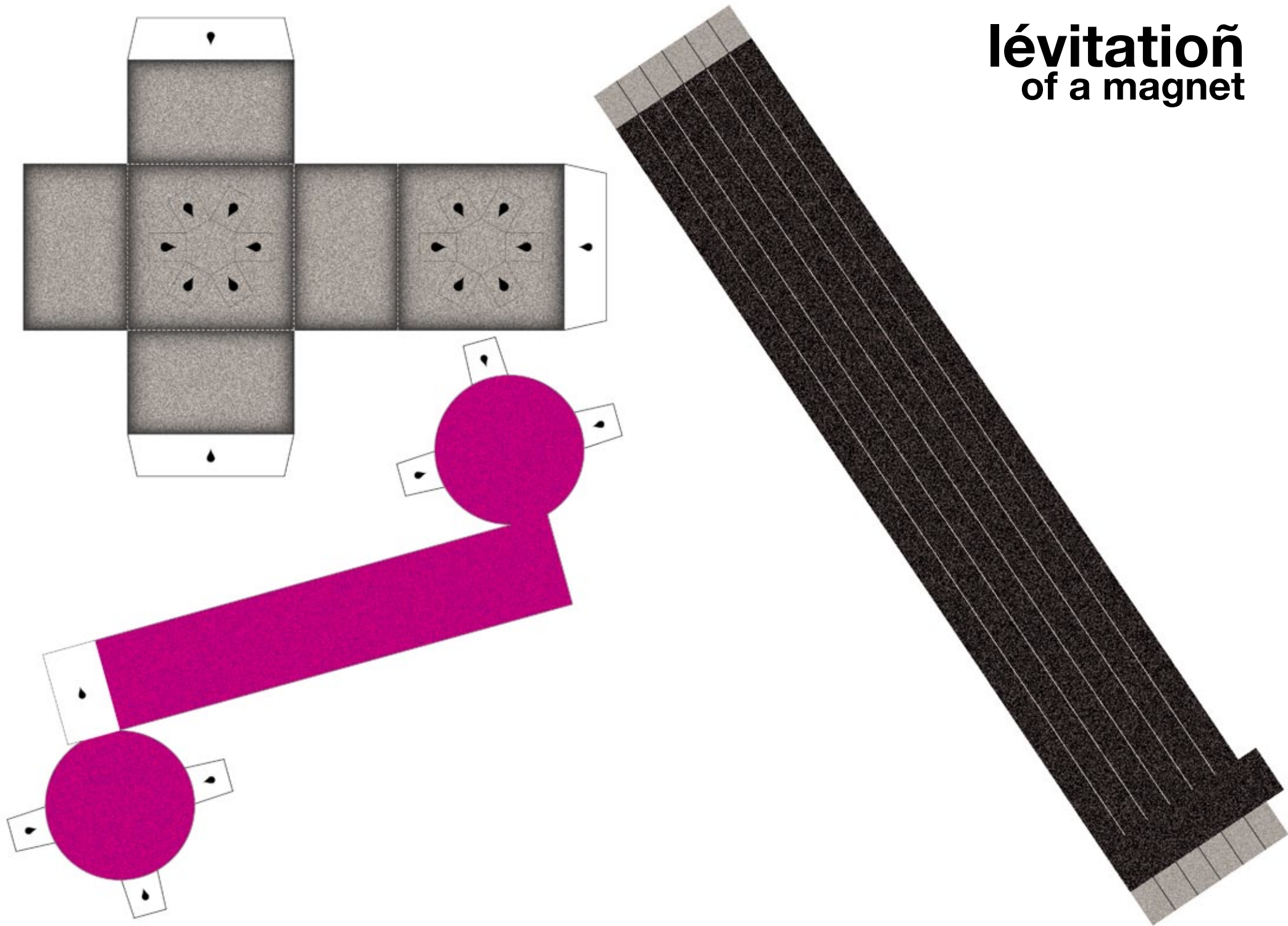

# lévitation of a magnet

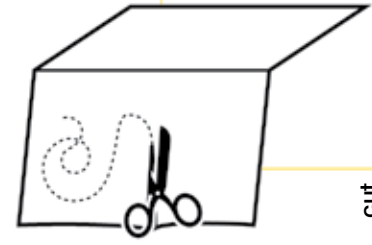

cut  
the magnet shape...

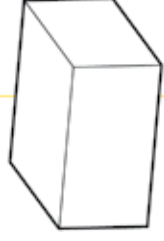
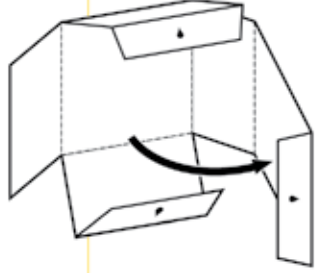
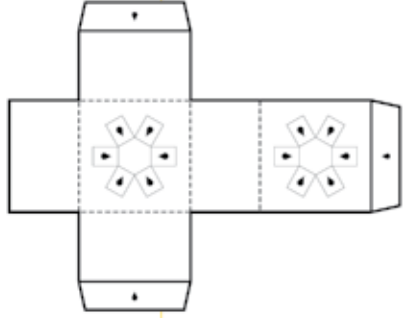

cut  
glue  
assemble

fold and glue  
following the dotted line  
to make a box...

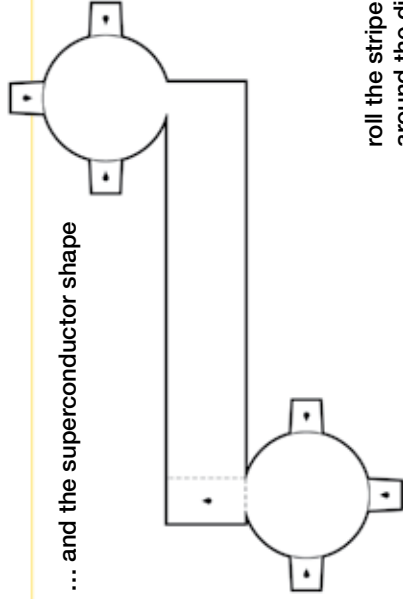

... and the superconductor shape

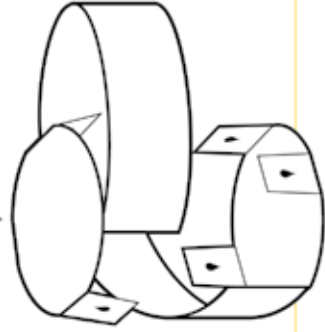
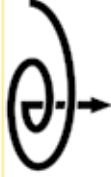

... and a cylinder



roll the stripe  
around the discs

cut the black  
stripes following  
the lines



fold  
the white  
tabs

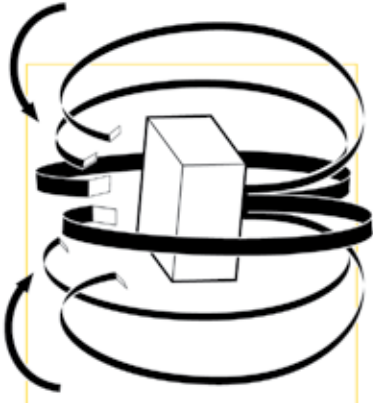
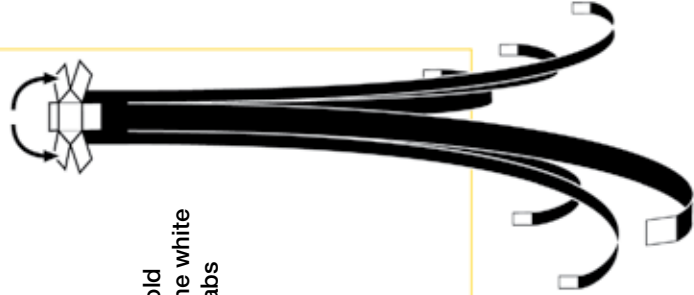
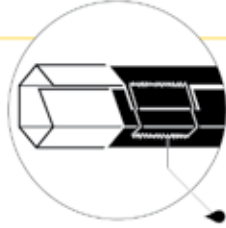

glue  
the stripes  
on the marks  
on both sides  
of the magnet

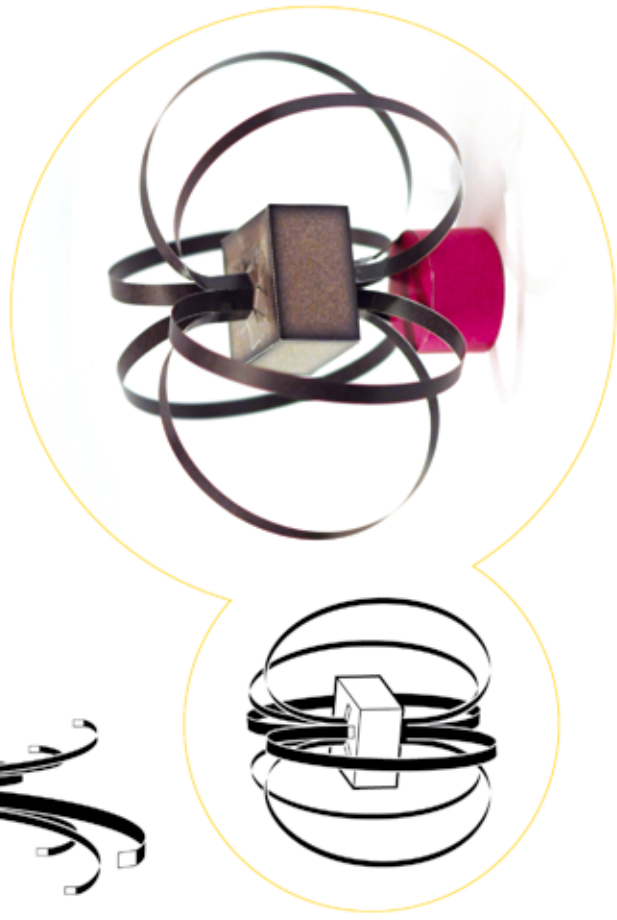
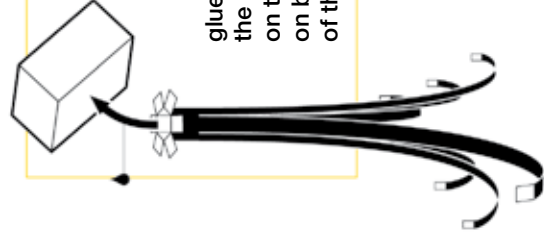



*Find all the models and instructions on  
[www.supraconductivite.fr](http://www.supraconductivite.fr)*

*Graphic design: Cyril Conton*

*Texts: Julien Bobroff (Laboratoire de physique des Solides,  
Université Paris-Sud et CNRS)*

*This project was created during a diploma of DSAA (science  
illustration design) at the Ecole Estienne (Paris), for the  
celebration of the year of superconductivity 2011. It was  
supported by RTRA Triangle de Physique.*

*We would like to acknowledge the assistance of Frederic  
Bouquet (LPS, Orsay), Jean-Michel Courty and Catherine  
Dematteis (INP CNRS) Roland Lehoucq (CEA), and for the  
English version, Jeffrey Quilliam and Fabienne Béduneau.*

*All rights reserved J.Bobroff 2011*

**[www.supraconductivite.fr](http://www.supraconductivite.fr)**  
**[contact@supraconductivite.fr](mailto:contact@supraconductivite.fr)**